

Cennik produktów 2026



— od dnia —
01.07. 2026 r.

wprowadzona zostaje
dopłata materiałowa
w wysokości

3,2%

dotyczy klamek, rozet,
antab oraz nakładek
na zawiasy

Poczucie
bezpieczeństwa
zaczyna się teraz.

AXA HOME SECURITY

W związku ze znaczącym wzrostem cen aluminium, od dnia **01.07. 2026 r.** wprowadzona zostaje **dopłata materiałowa** w wysokości **3,2%**.

Dotyczy ona produktów, których głównym materiałem jest aluminium.

- Klamki
- Antaby
- Nasadki na zawiasy
- Szyldy oraz rozety





NOWOŚĆ!
PIERWSZA TAKA NA RYNKU

LEONARDO
PREMIUM CLICK



**ODWIEDŹ STRONĘ
I DOWIEDZ SIĘ WIĘCEJ**

fot. na okładce – Solid Flex Premium; u góry
– wizualizacja klamki Leonardo Premium Click,
widok od wnętrza mieszkania; AXA©.

Ostatnie trendy	2
Podstawowa i 1 klasa bezpieczeństwa	3
3 klasa bezpieczeństwa	4
4 klasa bezpieczeństwa	6
Antaby	7
Okucia dedykowane do antab	11
Pozostała oferta	13
Cyfrowy wizjer drzwiowy	13
Wizjer drzwiowy	13
Akcesoria dodatkowe	13
Osłonki na zawiasy	13
Wkładki patentowe	14
Wkładki pojedyncze	16
Odbojniki	20
Samozamykacze	20
Sztynny łańcuch	20
Zawias kryty	21
AXA Remote 2.0	21





LEONARDO PREMIUM CLICK

F6

F8

Katalog str. 12

OKUCIE	F6: NETTO	F6: BRUTTO	F8: NETTO	F8: BRUTTO
klamko-klamka	319,00	392,37	367,00	451,41
klamko-pochwył	342,00	420,66	393,00	483,39
rozeta	169,00	207,87	194,00	238,62

Istnieje możliwość wykończenia w dowolnym kolorze RAL, przy zamówieniu min. 100 szt.
O szczegóły pytaj w dziale handlowym.



LIBERA

F3

F6

F8

Katalog str. 14

OKUCIE	F3, F6, F8: NETTO	F3, F6, F8: BRUTTO
klamko-klamka	256,00	314,88
klamko-klamka + rozeta WB	301,00	370,23
klamko-klamka + rozeta WK	309,00	380,07
klamko-klamka + rozeta WC	345,00	424,35
klamko-klamka + rozeta WB 3 klasa	477,00	586,71
rozeta WB	90,00	110,70
rozeta WK	107,00	131,61
rozeta WC	177,00	217,71
rozeta WB 3 klasa	222,00	273,06



VERONA++ FLEX

F4

F8

Katalog str. 16

OKUCIE	F4, F8: NETTO	F4, F8: BRUTTO
klamko-klamka	354,00	435,42
klamko-gałka	378,00	464,94
rozeta	212,00	260,76

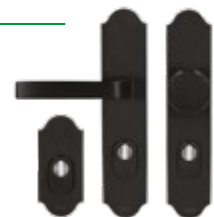

CAMELOT



Katalog str. 18

OKUCIE	NETTO	BRUTTO
klamka z zamkiem	1552,00	1908,96
rozeta z zamkiem	652,00	801,96



PODSTAWOWA I 1 KLASA BEZPIECZEŃSTWA



CERES CLICK

F6

F8

Katalog str. 22

OKUCIE	F6: NETTO	F6: BRUTTO	F8: NETTO	F8: BRUTTO
klamko-klamka + rozeta WB	241,00	296,43	275,00	338,25
klamko-gałka + rozeta WB	264,00	324,72	302,00	371,46
rozeta WB	81,00	99,63	91,00	111,93



FAST PREMIUM

F3

F6

F8

Katalog str. 24

OKUCIE	F6: NETTO	F6: BRUTTO	F3, F8: NETTO	F3, F8: BRUTTO
klamko-klamka	173,00	212,79	200,00	246,00
klamko-gałka ruchoma	205,00	252,15	235,00	289,05
rozeta	53,00	65,19	64,00	78,72
rozeta długa	57,00	70,11	70,00	86,10



SLIM++

F4

F6

F8

Katalog str. 26

OKUCIE	F6: NETTO	F6: BRUTTO	F4, F8: NETTO	F4, F8: BRUTTO
klamko-klamka	131,00	161,13	151,00	185,73
klamko-pochwył	150,00	184,50	171,00	210,33
rozeta	76,00	93,48	87,00	107,01

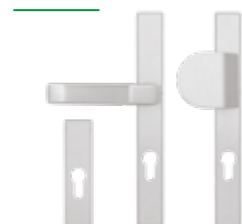

NIAGARA++

F4

F6

Katalog str. 28

OKUCIE	F6: NETTO	F6: BRUTTO	F4: NETTO	F4: BRUTTO
klamko-klamka	135,00	166,05	156,00	191,88
klamko-pochwył	150,00	184,50	172,00	211,56
rozeta	53,00	65,19	64,00	78,72
rozeta długa	57,00	70,11	70,00	86,10

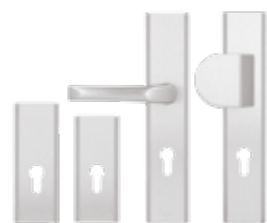

HAGA++

F1

F4

F6

F8

F9

Katalog str. 30

OKUCIE	F1, F6, F9: NETTO	F1, F6, F9: BRUTTO	F4, F8: NETTO	F4, F8: BRUTTO
klamko-klamka	143,00	175,89	163,00	200,49
klamko-pochwył	158,00	194,34	182,00	223,86
rozeta	53,00	65,19	64,00	78,72
rozeta długa	57,00	70,11	70,00	86,10

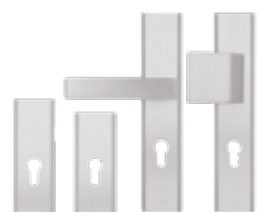

MANITOBA++

F4

F6

Katalog str. 32

OKUCIE	F6: NETTO	F6: BRUTTO	F4: NETTO	F4: BRUTTO
klamko-klamka	141,00	173,43	162,00	199,26
klamko-pochwył	158,00	194,34	181,00	222,63
rozeta	53,00	65,19	64,00	78,72

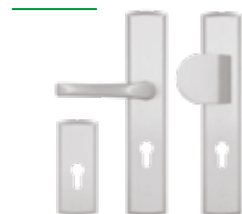

3 KLASA BEZPIECZEŃSTWA



DIVA++

F4 F6

Katalog str. 36

OKUCIE	F6: NETTO	F6: BRUTTO	F4: NETTO	F4: BRUTTO
klamko-klamka	254,00	312,42	291,00	357,93
klamko-gałka	280,00	344,40	322,00	396,06
rozeta	133,00	163,59	162,00	199,26



DIVA++ FLEX

F4 F6

Katalog str. 38

OKUCIE	F6: NETTO	F6: BRUTTO	F4: NETTO	F4: BRUTTO
klamko-klamka	294,00	361,62	339,00	416,97
rozeta	174,00	214,02	201,00	247,23



ODIN++

F4 F6

Katalog str. 40

OKUCIE	F6: NETTO	F6: BRUTTO	F4: NETTO	F4: BRUTTO
klamko-klamka	254,00	312,42	291,00	357,93
rozeta	133,00	163,59	162,00	199,26



ODIN++ FLEX

F1 F6

Katalog str. 42

OKUCIE	F1, F6: NETTO	F1, F6: BRUTTO
klamko-klamka	294,00	361,62
rozeta	174,00	214,02



QUEBEC++

F4 F6

Katalog str. 44

OKUCIE	F6: NETTO	F6: BRUTTO	F4: NETTO	F4: BRUTTO
klamko-klamka	254,00	312,42	291,00	357,93
rozeta	133,00	163,59	162,00	199,26

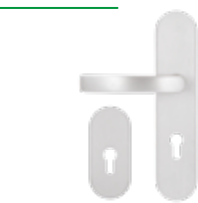

PRESTIGE++

F1 F4 F6

Katalog str. 46

OKUCIE	F1, F6: NETTO	F1, F6: BRUTTO	F4: NETTO	F4: BRUTTO
klamko-klamka	264,00	324,72	304,00	373,92
klamko-gałka	291,00	357,93	335,00	412,05
rozeta	140,00	172,20	161,00	198,03
rozeta długa	149,00	183,27	171,00	210,33



PRESTIGE++ FLEX

F1 F3 F4 F6 F8 F9

Katalog str. 48

OKUCIE	F1, F6, F9: NETTO	F1, F6, F9: BRUTTO	F3, F4, F8: NETTO	F3, F4, F8: BRUTTO
klamko-klamka	301,00	370,23	343,00	421,89
klamko-gałka	324,00	398,52	367,00	451,41
rozeta	182,00	223,86	201,00	247,23
rozeta długa	193,00	237,39	214,00	263,22



ROYAL++



Katalog str. 50

OKUCIE	F1, F6, F9: NETTO	F1, F6, F9: BRUTTO	F3, F4, F8: NETTO	F3, F4, F8: BRUTTO
klamko-klamka	264,00	324,72	304,00	373,92
rozeta	140,00	172,20	161,00	198,03

ROYAL++ FLEX



Katalog str. 52

OKUCIE	F1, F6: NETTO	F1, F6: BRUTTO	F4, F8: NETTO	F4, F8: BRUTTO
klamko-klamka	301,00	370,23	343,00	421,89
klamko-pochwyt	324,00	398,52	367,00	451,41
pochwyt-pochwyt (tylko F6)	401,00	493,23	-	-
rozeta	182,00	223,86	201,00	247,23

KIOTO FLEX PREMIUM



Katalog str. 54

OKUCIE	K7: NETTO	K7: BRUTTO
klamko-klamka	391,00	480,93
rozeta	201,00	247,23

APOLLO FLEX PREMIUM



Katalog str. 56

OKUCIE	F6: NETTO	F6: BRUTTO	F8: NETTO	F8: BRUTTO
klamko-klamka	340,00	418,20	391,00	480,93
klamko-pochwyt	370,00	455,10	426,00	523,98
rozeta	174,00	214,02	201,00	247,23

JUPITER FLEX PREMIUM



Katalog str. 58

OKUCIE	F6: NETTO	F6: BRUTTO	F4, F8: NETTO	F4, F8: BRUTTO
klamko-klamka	340,00	418,20	391,00	480,93
klamko-pochwyt	370,00	455,10	426,00	523,98
rozeta	174,00	214,02	201,00	247,23

ARROW FLEX PREMIUM



Katalog str. 60

OKUCIE	F6: NETTO	F6: BRUTTO	F8: NETTO	F8: BRUTTO
klamko-klamka	340,00	418,20	391,00	480,93
klamko-pochwyt	370,00	455,10	426,00	523,98
rozeta	174,00	214,02	201,00	247,23

SOLID FLEX PREMIUM



Katalog str. 62

OKUCIE	F1, F6: NETTO	F1, F6: BRUTTO	F4, F8: NETTO	F4, F8: BRUTTO
klamko-klamka (rozstaw 92)	340,00	418,20	391,00	480,93
klamko-pochwyt	370,00	455,10	426,00	523,98
klamko-gałka ruchoma click	396,00	487,08	455,00	559,65
rozeta	174,00	214,02	201,00	247,23



DIANA FLEX CLICK

F6 F8

Katalog str. 64

OKUCIE	F6: NETTO	F6: BRUTTO	F8: NETTO	F8: BRUTTO
klamko-klamka + rozeta WB	361,00	444,03	413,00	507,99
klamko-gałka + rozeta WB	379,00	466,17	435,00	535,05
rozeta WB	195,00	239,85	222,00	273,06



MARS FLEX CLICK

F6 F8

Katalog str. 66

OKUCIE	F6: NETTO	F6: BRUTTO	F8: NETTO	F8: BRUTTO
klamko-klamka + rozeta WB	361,00	444,03	413,00	507,99
klamko-gałka + rozeta WB	379,00	466,17	435,00	535,05
rozeta WB	195,00	239,85	222,00	273,06



4 KLASA BEZPIECZEŃSTWA



VERMONT++ FLEX

F6 F8

Katalog str. 68

OKUCIE	F6, F8: NETTO	F6, F8: BRUTTO
klamko-klamka	518,00	637,14
rozeta	281,00	345,63



INDYWIDUALNA KOMBINACJA PRODUKTÓW AXA

TYP	ILOŚĆ*	NETTO**	BRUTTO**
Indywidualna kombinacja	min. 100 szt.	Cena >+ 15% w zależności od kombinacji	-
Własne logo	min. 50 szt.	10,00	12,30
Własne logo	min. 100 szt.	7,00	8,61

* minimalna ilość dotyczy jednego rozstawu, koloru, rodzaju

** bez upustów

fot. AXA©.





VERONA SKOS

F4 F8

Katalog str. 76

DŁUGOŚĆ I SPOSÓB MONTAŻU	F4, F8: NETTO	F4, F8: BRUTTO
50 cm drewnokręt	648,00	797,04
170 cm drewnokręt	711,00	874,53

ELEMENTY MONTAŻOWE DO ANTAB*	NETTO	BRUTTO
Do drzwi aluminiowych (antaba drewnokręt)	22,00	27,06
Do drzwi PVC (antaba drewnokręt)	37,00	45,51

* bez upustów



DUBAJ

F6 F8

Katalog str. 78

SPOSÓB MONTAŻU	F6: NETTO	F6: BRUTTO	F8: NETTO	F8: BRUTTO
do drewna	614,00	755,22	706,00	868,38
na przestrzał	696,00	856,08	802,00	986,46
do aluminium	573,00	704,79	660,00	811,80
do PVC	626,00	769,98	720,00	885,60

DODATKOWE SŁUPKI	F6: NETTO	F6: BRUTTO	F8: NETTO	F8: BRUTTO
do drewna	346,00	425,58	398,00	489,54
na przestrzał	404,00	496,92	464,00	570,72
do aluminium	346,00	425,58	398,00	489,54
do PVC	404,00	496,92	464,00	570,72

SZANGHAJ

F6 F8

Katalog str. 80

SPOSÓB MONTAŻU	F6: NETTO	F6: BRUTTO	F8: NETTO	F8: BRUTTO
do drewna	577,00	709,71	664,00	816,72
na przestrzał	660,00	811,80	758,00	932,34
do aluminium	599,00	736,77	688,00	846,24
do PVC	652,00	801,96	748,00	920,04

DODATKOWE SŁUPKI	F6: NETTO	F6: BRUTTO	F8: NETTO	F8: BRUTTO
do drewna	346,00	425,58	398,00	489,54
na przestrzał	404,00	496,92	464,00	570,72
do aluminium	346,00	425,58	398,00	489,54
do PVC	404,00	496,92	464,00	570,72



ANTABY BEZPRZEWODOWE WAVES MONTREAL I AMSTERDAM

Antaba Waves dostępna w opcji bezprzewodowej 320 zł netto do ceny antaby z elektro przyciskiem.

ELEMENTY MONTAŻOWE DO ANTAB MONTREAL I AMSTERDAM*	NETTO	BRUTTO
Do drzwi aluminiowych (antaba drewnokręt)	22,00	27,06
Do drzwi PVC (antaba drewnokręt)	37,00	45,51
Funkcja termo (antaba przestrzał)	49,00	60,27

* bez upustów

MONTREAL PROSTA



Katalog str. 82

1-stronna

DŁUGOŚĆ I SPOSÓB MONTAŻU	F6: NETTO	F6: BRUTTO	F4, F8: NETTO	F4, F8: BRUTTO
100 cm drewnokręt	397,00	488,31	452,00	555,96
120 cm drewnokręt	410,00	504,30	467,00	574,41
150 cm drewnokręt	426,00	523,98	485,00	596,55
170 cm drewnokręt	448,00	551,04	509,00	626,07
100 cm na przestrzał	455,00	559,65	517,00	635,91
120 cm na przestrzał	497,00	611,31	567,00	697,41
150 cm na przestrzał	517,00	635,91	590,00	725,70
170 cm na przestrzał	526,00	646,98	600,00	738,00

2-stronna

DŁUGOŚĆ I SPOSÓB MONTAŻU	F6: NETTO	F6: BRUTTO	F4, F8: NETTO	F4, F8: BRUTTO
100 cm na przestrzał	766,00	942,18	868,00	1067,64
120 cm na przestrzał	853,00	1049,19	971,00	1194,33
150 cm na przestrzał	892,00	1097,16	1019,00	1253,37
170 cm na przestrzał	918,00	1129,14	1039,00	1277,97

elektro przycisk

DŁUGOŚĆ I SPOSÓB MONTAŻU	F6: NETTO	F6: BRUTTO	F4, F8: NETTO	F4, F8: BRUTTO
100 cm drewnokręt	551,00	677,73	621,00	763,83
120 cm drewnokręt	565,00	694,95	638,00	784,74
150 cm drewnokręt	583,00	717,09	662,00	814,26
170 cm drewnokręt	600,00	738,00	683,00	840,09
100 cm na przestrzał	609,00	749,07	692,00	851,16
120 cm na przestrzał	652,00	801,96	745,00	916,35
150 cm na przestrzał	672,00	826,56	761,00	936,03
170 cm na przestrzał	680,00	836,40	776,00	954,48

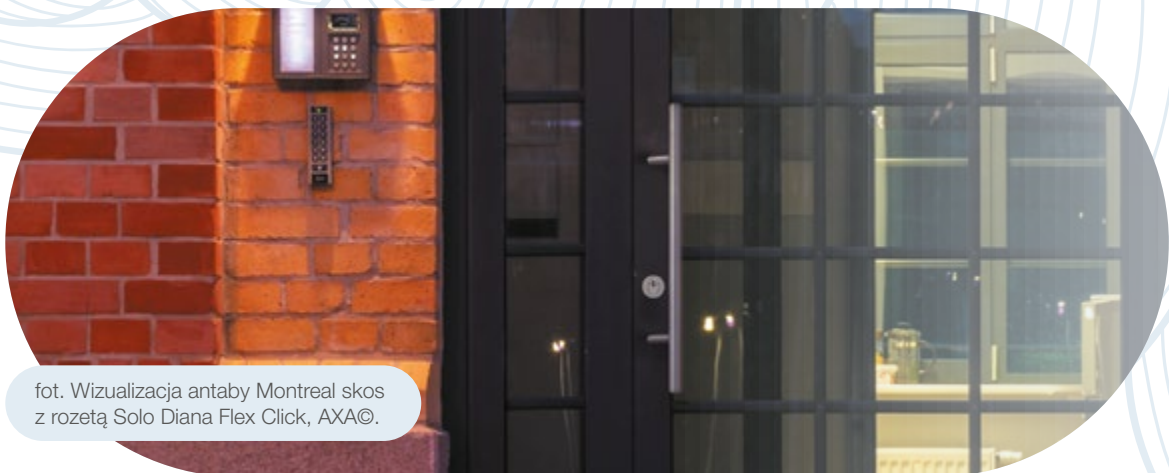

fot. Wizualizacja antaby Montreal skos z rozetą Solo Diana Flex Click, AXA©.



MONTREAL SKOS



Katalog str. 84

1-stronna

DŁUGOŚĆ I SPOSÓB MONTAŻU	F6: NETTO	F6: BRUTTO	F4, F8: NETTO	F4, F8: BRUTTO
100 cm drewnokręt	440,00	541,20	498,00	612,54
120 cm drewnokręt	459,00	564,57	521,00	640,83
150 cm drewnokręt	471,00	579,33	535,00	658,05
170 cm drewnokręt	488,00	600,24	555,00	682,65
100 cm na przestrzał	515,00	633,45	590,00	725,70
120 cm na przestrzał	560,00	688,80	638,00	784,74
150 cm na przestrzał	580,00	713,40	660,00	811,80
170 cm na przestrzał	590,00	725,70	673,00	827,79

2-stronna

DŁUGOŚĆ I SPOSÓB MONTAŻU	F6: NETTO	F6: BRUTTO	F4, F8: NETTO	F4, F8: BRUTTO
100 cm na przestrzał	889,00	1093,47	1008,00	1239,84
120 cm na przestrzał	978,00	1202,94	1113,00	1368,99
150 cm na przestrzał	1015,00	1248,45	1148,00	1412,04
170 cm na przestrzał	1042,00	1281,66	1180,00	1451,40

elektro przycisk

DŁUGOŚĆ I SPOSÓB MONTAŻU	F6: NETTO	F6: BRUTTO	F4, F8: NETTO	F4, F8: BRUTTO
100 cm drewnokręt	618,00	760,14	678,00	833,94
120 cm drewnokręt	640,00	787,20	702,00	863,46
150 cm drewnokręt	650,00	799,50	706,00	868,38
170 cm drewnokręt	669,00	822,87	736,00	905,28
100 cm na przestrzał	696,00	856,08	771,00	948,33
120 cm na przestrzał	743,00	913,89	817,00	1004,91
150 cm na przestrzał	760,00	934,80	841,00	1034,43
170 cm na przestrzał	771,00	948,33	853,00	1049,19

1-stronna

DŁUGOŚĆ I SPOSÓB MONTAŻU	F6: NETTO	F6: BRUTTO	F8: NETTO	F8: BRUTTO
100 cm drewnokręt	396,00	487,08	453,00	557,19
120 cm drewnokręt	446,00	548,58	510,00	627,30
150 cm drewnokręt	460,00	565,80	530,00	651,90
170 cm drewnokręt	469,00	576,87	540,00	664,20
100 cm na przestrzał	494,00	607,62	565,00	694,95
120 cm na przestrzał	543,00	667,89	623,00	766,29
150 cm na przestrzał	560,00	688,80	645,00	793,35
170 cm na przestrzał	573,00	704,79	659,00	810,57
DŁUGOŚĆ I SPOSÓB MONTAŻU	F3: NETTO		F3: BRUTTO	
160 cm drewnokręt	650,00		799,50	

2-stronna

DŁUGOŚĆ I SPOSÓB MONTAŻU	F6: NETTO	F6: BRUTTO	F8: NETTO	F8: BRUTTO
100 cm na przestrzał	842,00	1035,66	967,00	1189,41
120 cm na przestrzał	943,00	1159,89	1085,00	1334,55
150 cm na przestrzał	977,00	1201,71	1125,00	1383,75
170 cm na przestrzał	1000,00	1230,00	1149,00	1413,27

elektro przycisk

DŁUGOŚĆ I SPOSÓB MONTAŻU	F6: NETTO	F6: BRUTTO	F8: NETTO	F8: BRUTTO
100 cm drewnokręt	550,00	676,50	630,00	774,90
120 cm drewnokręt	598,00	735,54	689,00	847,47
150 cm drewnokręt	613,00	753,99	705,00	867,15
170 cm drewnokręt	626,00	769,98	720,00	885,60
100 cm na przestrzał	646,00	794,58	744,00	915,12
120 cm na przestrzał	696,00	856,08	800,00	984,00
150 cm na przestrzał	717,00	881,91	824,00	1013,52
170 cm na przestrzał	728,00	895,44	837,00	1029,51

1-stronna

DŁUGOŚĆ I SPOSÓB MONTAŻU	F6: NETTO	F6: BRUTTO	F8: NETTO	F8: BRUTTO
100 cm drewnokręt	540,00	664,20	617,00	758,91
120 cm drewnokręt	585,00	719,55	673,00	827,79
150 cm drewnokręt	605,00	744,15	695,00	854,85
170 cm drewnokręt	613,00	753,99	705,00	867,15
100 cm na przestrzał	639,00	785,97	731,00	899,13
120 cm na przestrzał	687,00	845,01	787,00	968,01
150 cm na przestrzał	702,00	863,46	809,00	995,07
170 cm na przestrzał	714,00	878,22	819,00	1007,37

AMSTERDAM SKOS CD.

2-stronna

DŁUGOŚĆ SPOSÓB MONTAŻU	F6: NETTO	F6: BRUTTO	F8: NETTO	F8: BRUTTO
100 cm na przestrzał	1138,00	1399,74	1306,00	1606,38
120 cm na przestrzał	1233,00	1516,59	1416,00	1741,68
150 cm na przestrzał	1269,00	1560,87	1458,00	1793,34
170 cm na przestrzał	1290,00	1586,70	1483,00	1824,09

elektro przycisk

DŁUGOŚĆ SPOSÓB MONTAŻU	F6: NETTO	F6: BRUTTO	F8: NETTO	F8: BRUTTO
100 cm drewnokręt	720,00	885,60	826,00	1015,98
120 cm drewnokręt	767,00	943,41	882,00	1084,86
150 cm drewnokręt	786,00	966,78	904,00	1111,92
170 cm drewnokręt	795,00	977,85	913,00	1122,99
100 cm na przestrzał	818,00	1006,14	939,00	1154,97
120 cm na przestrzał	865,00	1063,95	994,00	1222,62
150 cm na przestrzał	884,00	1087,32	1015,00	1248,45
170 cm na przestrzał	892,00	1097,16	1027,00	1263,21

OKUCIA DEDYKOWANE DO ANTAB

SOLO JUPITER ELECTRO FLEX PREMIUM

F6 F8

Katalog str. 91

OKUCIE	F6: NETTO	F6: BRUTTO	F8: NETTO	F8: BRUTTO
klamka + krótki szyld	536,00	659,28	616,00	757,68
rozeta	166,00	204,18	191,00	234,93



SOLO LIBERA FLEX

F3 F6 F8

Katalog str. 92

OKUCIE	F6, F8: NETTO	F6, F8: BRUTTO
klamko-rozeta + rozeta WB	381,00	468,63
rozeta	222,00	273,06



SOLO VERONA++ FLEX

F4 F8

Katalog str. 92

OKUCIE	F4, F8: NETTO	F4, F8: BRUTTO
klamka + długi szyld	340,00	418,20
rozeta	212,00	260,76



SOLO SLIM++



Katalog str. 92

OKUCIE	F6: NETTO	F6: BRUTTO	F8: NETTO	F8: BRUTTO
klamka + krótki szyld	128,00	157,44	146,00	179,58
rozeta	76,00	93,48	87,00	107,01



SOLO GAJA++



Katalog str. 92

OKUCIE	F6: NETTO	F6: BRUTTO	F4, F8: NETTO	F4, F8: BRUTTO
klamka + krótki szyld	166,00	204,18	185,00	227,55
rozeta	81,00	99,63	91,00	111,93



SOLO MARS FLEX CLICK



Katalog str. 93

OKUCIE	F6: NETTO	F6: BRUTTO	F8: NETTO	F8: BRUTTO
klamko-rozeta + rozeta WB	330,00	405,90	379,00	466,17
rozeta	195,00	239,85	222,00	273,06



SOLO DIANA FLEX CLICK



Katalog str. 93

OKUCIE	F6: NETTO	F6: BRUTTO	F8: NETTO	F8: BRUTTO
klamko-rozeta + rozeta WB	330,00	405,90	379,00	466,17
rozeta	195,00	239,85	222,00	273,06



SOLO SOLID FLEX PREMIUM



Katalog str. 93

OKUCIE	F6: NETTO	F6: BRUTTO	F8: NETTO	F8: BRUTTO
klamka + krótki szyld	298,00	366,54	340,00	418,20
rozeta	174,00	214,02	201,00	247,23



SOLO ROYAL++ FLEX



Katalog str. 93

OKUCIE	F6: NETTO	F6: BRUTTO	F8: NETTO	F8: BRUTTO
klamka + długi szyld	556,00	683,88	623,00	766,29
rozeta	182,00	223,86	201,00	247,23



INDYWIDUALNA KOMBINACJA PRODUKTÓW AXA

TYP	ILOŚĆ*	NETTO**	BRUTTO**
Indywidualna kombinacja	min. 100 szt.	Cena >+ 15% w zależności od kombinacji	-
Własne logo	min. 50 szt.	10,00	12,30
Własne logo	min. 100 szt.	7,00	8,61

* minimalna ilość dotyczy jednego rozstawu, koloru, rodzaju.

** bez upustów

POZOSTAŁA OFERTA



CYFROWY WIZJER DRZWIOWY*

Katalog str. 96

PRODUKT	NETTO	BRUTTO
Wizjer cyfrowy AXA DDS 1	261,00	321,03
Wizjer cyfrowy AXA DDS 2	362,00	445,26

DDS 1



DDS 2



*max. upust 25%

WIZJER DRZWIOWY

Katalog str. 96

PRODUKT	NETTO	BRUTTO
Ekono srebrny	21,00	25,83
Ekono black	21,00	25,83
Premium black	33,00	40,59
Premium inox	33,00	40,59



Ekono srebrny



Ekono black



Premium inox



Premium black

AKCESORIA DODATKOWE

Katalog str. 97

PRODUKT	ILOŚĆ	NETTO	BRUTTO
śruby 6 cm	5 sztuk	13,00	15,99
śruby 8 cm	5 sztuk	13,00	15,99
śruby 9 cm	5 sztuk	13,00	15,99
śruby 10 cm	5 sztuk	cena na zapytanie	-
trzczeń klamko-klamki dł. 110, 130 mm ++	10 sztuk	125,00	153,75
trzczeń klamko-klamki dł. 150, 165 mm ++	10 sztuk	136,00	167,28
trzczeń klamko-klamki dł. 110, 140, 150 mm premium	10 sztuk	120,00	147,60
trzczeń klamko-klamki dł. 170 mm premium	10 sztuk	140,00	172,20
trzczeń klamko-gałki dł. 75, 85, 110, 120, 125 mm	10 sztuk	172,00	211,56
tulejka 30 mm	1 sztuka	17,70	21,77

OSŁONKI NA ZAWIASY



Katalog str. 97

ILOŚĆ	F1, F6, F9: NETTO	F1, F6, F9: BRUTTO	F3, F4, F8: NETTO	F3, F4, F8: BRUTTO
komplet 12 sztuk	10,00	12,30	12,00	14,76



Komplet zawiera:

- wkładkę dwustronną + wkładkę z gałką,
- 5 kluczy,
- kartę bezpieczeństwa (klasa C),
- 2 śruby mocujące.

Dostępna kolorystyka gałki:

Ceny detaliczne PLN netto/zestaw.

Klasa B

WYMIAR	F1, F6, F9: NETTO	F1, F6, F9: BRUTTO	F3, F4, F8: NETTO	F3, F4, F8: BRUTTO
1484 26/35 + 1481 26/35	229,30	282,04	242,80	298,64
1484 26/40 + 1481 26/40	260,80	320,78	274,30	337,39
1484 26/45 + 1481 26/45	274,40	337,51	287,90	354,12
1484 26/50 + 1481 26/50	288,00	354,24	301,50	370,85
1484 26/55 + 1481 26/55	298,10	366,66	311,60	383,27
1405 30/30 + 1400 30/30	233,60	287,33	247,20	304,06
1405 30/35 + 1400 30/35	229,30	282,04	242,80	298,64
1405 30/40 + 1400 30/40	242,20	297,91	255,70	314,51
1405 30/45 + 1400 30/45	255,10	313,77	268,60	330,38
1405 30/50 + 1400 30/50	268,10	329,76	281,60	346,37
1405 30/55 + 1400 30/55	280,80	345,38	294,40	362,11
1405 30/60 + 1400 30/60	293,10	360,51	306,60	377,12
1405 30/65 + 1400 30/65	305,80	376,13	319,30	392,74
1404 30/70 + 1400 30/70 *	318,80	392,12	332,30	408,73
1404 30/75 + 1400 30/75 *	672,60	827,30	686,10	843,90
1405 35/35 + 1400 35/35	242,20	297,91	255,70	314,51
1405 35/40 + 1400 35/40	255,10	313,77	268,60	330,38
1405 35/45 + 1400 35/45	268,10	329,76	281,60	346,37
1405 35/50 + 1400 35/50	280,80	345,38	294,40	362,11
1405 35/55 + 1400 35/55	293,10	360,51	306,60	377,12
1405 35/60 + 1400 35/60	305,80	376,13	319,30	392,74
1405 35/65 + 1400 35/65	339,00	416,97	352,50	433,58
1404 35/70 + 1400 35/70 *	351,70	432,59	365,20	449,20
1405 35/75 + 1400 35/75 *	721,40	887,32	734,90	903,93
1405 40/40 + 1400 40/40	268,10	329,76	281,60	346,37
1405 40/45 + 1400 40/45	280,80	345,38	294,40	362,11
1405 40/50 + 1400 40/50	293,10	360,51	306,60	377,12
1405 40/55 + 1400 40/55	305,80	376,13	319,30	392,74
1405 40/60 + 1400 40/60	318,80	392,12	332,30	408,73
1405 40/65 + 1400 40/65	331,10	407,25	344,60	423,86
1405 40/70 + 1400 40/70 *	343,90	423,00	357,40	439,60
1406 40/75 + 1400 40/75 *	769,30	946,24	782,90	962,97
1405 45/45 + 1400 45/45	293,10	360,51	306,60	377,12
1405 45/50 + 1400 45/50	305,80	376,13	319,30	392,74
1405 45/55 + 1400 45/55	318,20	391,39	331,70	407,99
1405 45/60 + 1400 45/60	351,70	432,59	365,20	449,20
1405 45/65 + 1400 45/65	365,50	449,57	379,00	466,17

* Termin dostawy na zapytanie. Ceny mogą ulec zmianie.

WYMIAR	F1, F6, F9: NETTO	F1, F6, F9: BRUTTO	F3, F4, F8: NETTO	F3, F4, F8: BRUTTO
1404 45/70 + 1400 45/70*	404,10	497,04	417,60	513,65
1405 45/75 + 1400 45/75*	818,60	1006,88	832,20	1023,61
1405 50/50 + 1400 50/50	318,20	391,39	331,70	407,99
1405 50/55 + 1400 50/55	331,10	407,25	344,60	423,86
1405 50/60 + 1400 50/60	352,50	433,58	366,00	450,18
1404 50/65 + 1400 50/65	380,50	468,02	394,00	484,62
1404 50/70 + 1400 50/70 *	496,40	610,57	510,00	627,30
1405 50/75 + 1400 50/75 *	866,70	1066,04	880,20	1082,65
1405 55/55 + 1400 55/55	343,90	423,00	357,40	439,60
1405 55/60 + 1400 55/60	380,50	468,02	394,00	484,62
1403 55/65 + 1400 55/65	417,00	512,91	430,50	529,52
1404 55/70 + 1400 55/70 *	545,70	671,21	559,30	687,94
1405 55/75 + 1400 55/75 *	915,40	1125,94	928,90	1142,55
1405 60/60 + 1400 60/60 *	417,00	512,91	430,50	529,52
1404 60/65 + 1400 60/65 *	453,50	557,81	467,00	574,41

ABHIII W235

WYMIAR	F1, F6, F9: NETTO	F1, F6, F9: BRUTTO	F3, F4, F8: NETTO	F3, F4, F8: BRUTTO
1484 26/35 + 1481 26/35	291,70	358,79	305,20	375,40
1484 26/40 + 1481 26/40	303,90	373,80	317,50	390,53
1484 26/45 + 1481 26/45	315,30	387,82	328,80	404,42
1484 26/50 + 1481 26/50	327,40	402,70	341,00	419,43
1484 26/55 + 1481 26/55	339,00	416,97	352,50	433,58

Klasa C

WYMIAR	F1, F6, F9: NETTO	F1, F6, F9: BRUTTO	F3, F4, F8: NETTO	F3, F4, F8: BRUTTO
1405 30/30 + 1400 30/30	280,20	344,65	293,70	361,25
1405 30/35 + 1400 30/35	291,70	358,79	305,20	375,40
1405 30/40 + 1400 30/40	303,90	373,80	317,50	390,53
1405 30/45 + 1400 30/45	315,30	387,82	328,80	404,42
1405 30/50 + 1400 30/50	327,40	402,70	341,00	419,43
1405 30/55 + 1400 30/55	339,00	416,97	352,50	433,58
1405 30/60 + 1400 30/60	351,00	431,73	364,60	448,46
1405 30/65 + 1400 30/65	362,50	445,88	376,00	462,48
1404 30/70 + 1400 30/70 *	374,00	460,02	387,60	476,75
1404 30/75 + 1400 30/75 *	842,90	1036,77	856,40	1053,37
1405 35/35 + 1400 35/35	303,90	373,80	317,50	390,53
1405 35/40 + 1400 35/40	315,30	387,82	328,80	404,42
1405 35/45 + 1400 35/45	327,40	402,70	341,00	419,43
1405 35/50 + 1400 35/50	339,00	416,97	352,50	433,58
1405 35/55 + 1400 35/55	351,00	431,73	364,60	448,46
1405 35/60 + 1400 35/60	362,50	445,88	376,00	462,48
1405 35/65 + 1400 35/65	374,00	460,02	387,60	476,75
1404 35/70 + 1400 35/70 *	386,20	475,03	399,70	491,63

* Termin dostawy na zapytanie. Ceny mogą ulec zmianie.

WYMIAR	F1, F6, F9: NETTO	F1, F6, F9: BRUTTO	F3, F4, F8: NETTO	F3, F4, F8: BRUTTO
1405 35/75 + 1400 35/75 *	890,70	1095,56	904,20	1112,17
1405 40/40 + 1400 40/40	327,40	402,70	341,00	419,43
1405 40/45 + 1400 40/45	339,00	416,97	352,50	433,58
1405 40/50 + 1400 40/50	360,30	443,17	373,80	459,77
1405 40/55 + 1400 40/55	372,60	458,30	386,10	474,90
1405 40/60 + 1400 40/60	384,80	473,30	398,40	490,03
1405 40/65 + 1400 40/65	386,20	475,03	399,70	491,63
1405 40/70 + 1400 40/70 *	397,70	489,17	411,30	505,90
1406 40/75 + 1400 40/75 *	940,50	1156,82	954,00	1173,42
1405 45/45 + 1400 45/45	351,00	431,73	364,60	448,46
1405 45/50 + 1400 45/50	373,20	459,04	386,70	475,64
1405 45/55 + 1400 45/55	384,80	473,30	398,40	490,03
1405 45/60 + 1400 45/60	395,60	486,59	409,10	503,19
1405 45/65 + 1400 45/65	397,70	489,17	411,30	505,90
1404 45/70 + 1400 45/70*	431,30	530,50	444,90	547,23
1405 45/75 + 1400 45/75*	988,40	1215,73	1001,90	1232,34
1405 50/50 + 1400 50/50	384,80	473,30	398,40	490,03
1405 50/55 + 1400 50/55	386,20	475,03	399,70	491,63
1405 50/60 + 1400 50/60	424,20	521,77	437,70	538,37
1404 50/65 + 1400 50/65	431,30	530,50	444,90	547,23
1404 50/70 + 1400 50/70 *	606,70	746,24	620,20	762,85
1405 50/75 + 1400 50/75 *	1036,30	1274,65	1049,80	1291,25
1405 55/55 + 1400 55/55	397,70	489,17	411,30	505,90
1405 55/60 + 1400 55/60	431,30	530,50	444,90	547,23
1403 55/65 + 1400 55/65	464,90	571,83	478,40	588,43
1404 55/70 + 1400 55/70 *	655,50	806,27	669,00	822,87
1405 55/75 + 1400 55/75 *	1085,90	1335,66	1099,40	1352,26
1405 60/60 + 1400 60/60 *	464,90	571,83	478,40	588,43
1404 60/65 + 1400 60/65 *	498,60	613,28	512,10	629,88

WKŁADKI POJEDYNCZE BĘBENKOWE DWUSTRONNE

Komplet zawiera:

- wkładkę dwustronną,
- 5 kluczy,
- kartę bezpieczeństwa (klasa C),
- 2 śruby mocujące.

Dostępna kolorystyka:

- nikiel
- mosiądz



Ceny detaliczne PLN netto/zestaw.

Klasa B

WYMIAR	NETTO	BRUTTO	WYMIAR	NETTO	BRUTTO	WYMIAR	NETTO	BRUTTO
26/26	131,00	161,13	26/50	168,20	206,89	30/45	158,60	195,08
26/30	131,00	161,13	26/55	177,90	218,82	30/50	168,20	206,89
26/35	140,70	173,06	30/30	131,00	161,13	30/55	177,90	218,82
26/40	150,20	184,75	30/35	140,70	173,06	30/60	187,50	230,63
26/45	158,60	195,08	30/40	150,20	184,75	30/65	195,90	240,96

* Termin dostawy na zapytanie. Ceny mogą ulec zmianie.

WYMIAR	NETTO	BRUTTO
30/70 *	206,70	254,24
30/75 *	386,90	475,89
30/80 *	415,70	511,31
35/35	150,20	184,75
35/40	158,60	195,08
35/45	168,20	206,89
35/50	177,90	218,82
35/55	187,50	230,63
35/60	195,90	240,96
35/65	206,70	254,24
35/70 *	215,10	264,57
35/75 *	415,70	511,31
35/80 *	444,50	546,74
35/85 *	473,40	582,28
40/40	168,20	206,89

WYMIAR	NETTO	BRUTTO
40/45	177,90	218,82
40/50	187,50	230,63
40/55	195,90	240,96
40/60	206,70	254,24
40/65	215,10	264,57
40/70 *	224,70	276,38
40/75 *	444,50	546,74
40/80 *	473,40	582,28
40/90 *	531,10	653,25
45/45	187,50	230,63
45/50	195,90	240,96
45/55	206,70	254,24
45/60	215,10	264,57
45/65	224,70	276,38
45/70 *	253,60	311,93

WYMIAR	NETTO	BRUTTO
45/75 *	473,40	582,28
50/50	206,70	254,24
50/55	215,10	264,57
50/60	224,70	276,38
50/65	253,60	311,93
50/70 *	282,40	347,35
50/75 *	502,20	617,71
55/55	224,70	276,38
55/60	253,60	311,93
55/65	282,40	347,35
55/70 *	311,20	382,78
55/75 *	531,10	653,25
60/60 *	282,40	347,35
60/65 *	311,20	382,78
65/70 *	370,10	455,22

ABHIII W235

WYMIAR	NETTO	BRUTTO
26/26	215,10	264,57
26/30	215,10	264,57
26/35	225,90	277,86

WYMIAR	NETTO	BRUTTO
26/40	236,80	291,26
26/45	247,60	304,55

WYMIAR	NETTO	BRUTTO
26/50	258,40	317,83
26/55	268,00	329,64

Klasa C

WYMIAR	NETTO	BRUTTO
30/30	215,10	264,57
30/35	225,90	277,86
30/40	236,80	291,26
30/45	247,60	304,55
30/50	258,40	317,83
30/55	268,00	329,64
30/60	278,80	342,92
30/65	289,60	356,21
30/70 *	299,20	368,02
30/75 *	540,60	664,94
30/80 *	573,10	704,91
35/35	236,80	291,26
35/40	247,60	304,55
35/45	258,40	317,83
35/50	268,00	329,64
35/55	278,80	342,92
35/60	289,60	356,21
35/65	299,20	368,02

WYMIAR	NETTO	BRUTTO
35/70 *	310,00	381,30
35/75 *	573,10	704,91
35/80 *	605,50	744,77
35/85 *	636,70	783,14
40/40	258,40	317,83
40/45	268,00	329,64
40/50	278,80	342,92
40/55	289,60	356,21
40/60	299,20	368,02
40/65	310,00	381,30
40/70 *	319,60	393,11
40/75 *	605,50	744,77
40/80 *	636,70	783,14
40/90 *	701,60	862,97
45/45	278,80	342,92
45/50	289,60	356,21
45/55	299,20	368,02
45/60	310,00	381,30

WYMIAR	NETTO	BRUTTO
45/65	319,60	393,11
45/70 *	352,10	433,08
45/75 *	636,70	783,14
50/50	299,20	368,02
50/55	310,00	381,30
50/60	319,60	393,11
50/65	352,10	433,08
50/70 *	384,40	472,81
50/75 *	669,20	823,12
55/55	319,60	393,11
55/60	352,10	433,08
55/65	384,40	472,81
55/70 *	416,90	512,79
55/75 *	701,60	862,97
60/60 *	384,40	472,81
60/65 *	416,90	512,79
65/70 *	481,80	592,61

* Termin dostawy na zapytanie. Ceny mogą ulec zmianie.

WKŁADKI POJEDYNCZE Z GAŁKĄ

Komplet zawiera:

- wkładkę pojedynczą z gałką,
- 5 kluczy,
- kartę bezpieczeństwa (klasa C),
- 2 śruby mocujące.

Dostępna kolorystyka gałki:



Ceny detaliczne PLN netto/zestaw.

Klasa B

WYMIAR	F1, F6, F9: NETTO	F1, F6, F9: BRUTTO	F3, F4, F8: NETTO	F3, F4, F8: BRUTTO
26/26	174,10	214,14	187,70	230,87
26/30	174,10	214,14	187,70	230,87
26/35	183,50	225,71	197,00	242,31
26/40	192,90	237,27	206,40	253,87
26/45	202,80	249,44	216,40	266,17
26/50	212,20	261,01	225,70	277,61
26/55	221,60	272,57	235,10	289,17
30/30	174,10	214,14	187,70	230,87
30/35	183,50	225,71	197,00	242,31
30/40	195,80	240,83	209,30	257,44
30/45	202,80	249,44	216,40	266,17
30/50	212,20	261,01	225,70	277,61
30/55	221,60	272,57	235,10	289,17
30/60	230,80	283,88	244,30	300,49
30/65	240,10	295,32	253,60	311,93
30/70 *	249,50	306,89	263,10	323,61
30/75 *	440,90	542,31	454,40	558,91
35/35	192,90	237,27	206,40	253,87
35/40	202,80	249,44	216,40	266,17
35/45	212,20	261,01	225,70	277,61
35/50	221,60	272,57	235,10	289,17
35/55	230,80	283,88	244,30	300,49
35/60	240,10	295,32	253,60	311,93
35/65	249,50	306,89	263,10	323,61
35/70 *	258,80	318,32	272,30	334,93
35/75 *	474,80	584,00	488,30	600,61
40/40	212,20	261,01	225,70	277,61
40/45	221,60	272,57	235,10	289,17

WYMIAR	F1, F6, F9: NETTO	F1, F6, F9: BRUTTO	F3, F4, F8: NETTO	F3, F4, F8: BRUTTO
40/50	230,80	283,88	244,30	300,49
40/55	240,10	295,32	253,60	311,93
40/60	249,50	306,89	263,10	323,61
40/65	258,80	318,32	272,30	334,93
40/70 *	268,90	330,75	282,40	347,35
40/75 *	503,10	618,81	516,60	635,42
45/45	230,80	283,88	244,30	300,49
45/50	240,10	295,32	253,60	311,93
45/55	249,50	306,89	263,10	323,61
45/60	258,80	318,32	272,30	334,93
45/65	268,90	330,75	282,40	347,35
45/70 *	299,70	368,63	313,20	385,24
45/75 *	537,00	660,51	550,50	677,12
50/50	249,50	306,89	263,10	323,61
50/55	258,80	318,32	272,30	334,93
50/60	268,90	330,75	282,40	347,35
50/65	299,70	368,63	313,20	385,24
50/70 *	330,20	406,15	343,80	422,87
50/75 *	563,00	692,49	576,50	709,10
55/55	268,90	330,75	282,40	347,35
55/60	299,70	368,63	313,20	385,24
55/65	330,20	406,15	343,80	422,87
55/70 *	359,60	442,31	373,10	458,91
55/75 *	593,50	730,01	607,00	746,61
60/60 *	333,60	410,33	347,10	426,93
60/65 *	359,60	442,31	373,10	458,91
65/70 *	422,80	520,04	436,30	536,65

ABHIII W235

WYMIAR	F1, F6, F9: NETTO	F1, F6, F9: BRUTTO	F3, F4, F8: NETTO	F3, F4, F8: BRUTTO
26/26	265,90	327,06	279,40	343,66
26/30	265,90	327,06	279,40	343,66
26/35	276,70	340,34	290,20	356,95
26/40	286,60	352,52	300,10	369,12

WYMIAR	F1, F6, F9: NETTO	F1, F6, F9: BRUTTO	F3, F4, F8: NETTO	F3, F4, F8: BRUTTO
26/45	297,40	365,80	310,90	382,41
26/50	308,20	379,09	321,70	395,69
26/55	318,20	391,39	331,70	407,99

* Termin dostawy na zapytanie. Ceny mogą ulec zmianie.

Klasa C

WYMIAR	F1, F6, F9: NETTO	F1, F6, F9: BRUTTO	F3, F4, F8: NETTO	F3, F4, F8: BRUTTO
30/30	265,90	327,06	279,40	343,66
30/35	276,70	340,34	290,20	356,95
30/40	286,60	352,52	300,10	369,12
30/45	297,40	365,80	310,90	382,41
30/50	308,20	379,09	321,70	395,69
30/55	318,20	391,39	331,70	407,99
30/60	328,90	404,55	342,40	421,15
30/65	339,00	416,97	352,50	433,58
30/70 *	349,80	430,25	363,30	446,86
30/75 *	590,90	726,81	604,40	743,41
35/35	286,60	352,52	300,10	369,12
35/40	297,40	365,80	310,90	382,41
35/45	308,20	379,09	321,70	395,69
35/50	318,20	391,39	331,70	407,99
35/55	328,90	404,55	342,40	421,15
35/60	339,00	416,97	352,50	433,58
35/65	349,80	430,25	363,30	446,86
35/70 *	359,70	442,43	373,20	459,04
35/75 *	622,50	765,68	636,00	782,28
40/40	308,20	379,09	321,70	395,69
40/45	318,20	391,39	331,70	407,99
40/50	328,90	404,55	342,40	421,15
40/55	339,00	416,97	352,50	433,58
40/60	349,80	430,25	363,30	446,86

WYMIAR	F1, F6, F9: NETTO	F1, F6, F9: BRUTTO	F3, F4, F8: NETTO	F3, F4, F8: BRUTTO
40/65	359,70	442,43	373,20	459,04
40/70 *	370,40	455,59	383,90	472,20
40/75 *	654,60	805,16	668,10	821,76
45/45	328,90	404,55	342,40	421,15
45/50	339,00	416,97	352,50	433,58
45/55	349,80	430,25	363,30	446,86
45/60	359,70	442,43	373,20	459,04
45/65	370,40	455,59	383,90	472,20
45/70 *	402,60	495,20	416,20	511,93
45/75 *	686,90	844,89	700,40	861,49
50/50	349,80	430,25	363,30	446,86
50/55	359,70	442,43	373,20	459,04
50/60	370,40	455,59	383,90	472,20
50/65	402,60	495,20	416,20	511,93
50/70 *	434,90	534,93	448,40	551,53
50/75 *	719,20	884,62	732,70	901,22
55/55	370,40	455,59	383,90	472,20
55/60	402,60	495,20	416,20	511,93
55/65	434,90	534,93	448,40	551,53
55/70 *	467,10	574,53	480,60	591,14
55/75 *	751,20	923,98	764,80	940,70
60/60 *	434,90	534,93	448,40	551,53
60/65 *	467,10	574,53	480,60	591,14
65/70 *	531,00	653,13	544,50	669,74

fot. Wygląd wkładek zamontowanych w rozecie Prestige. AXA©.



Sposób mierzenia wkładek:

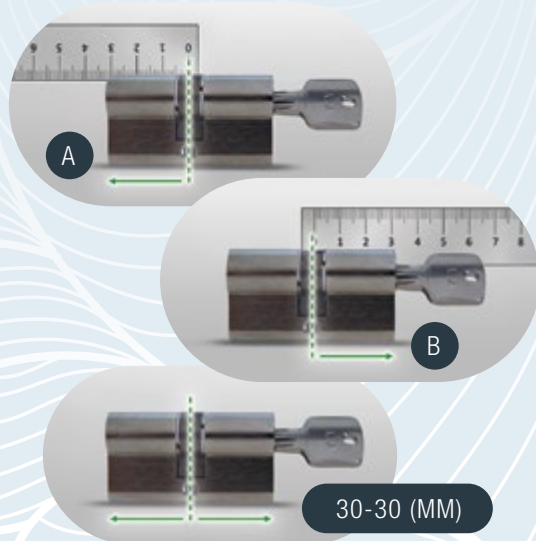

* Termin dostawy na zapytanie. Ceny mogą ulec zmianie.

ODBOJNIK AXA DO CIĘŻKICH DRZWI



Katalog str. 100

PRODUKT	F1, F6: NETTO	F1, F6: BRUTTO	F4, F8: NETTO	F4, F8: BRUTTO
Odbojnik MC-35	149,00	183,27	177,00	217,71
Odbojnik MC-50	221,00	271,83	253,00	311,19

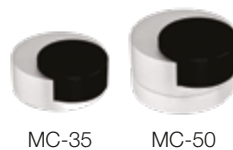

ODBOJNIKI ZE STALI NIERDZEWNEJ

Katalog str. 100

NUMER KATALOGOWY	NETTO	BRUTTO
6900-01-81/E	99,00	121,77
6900-02-81/E	37,00	45,51
6900-03-81/E	41,00	50,43
6900-04-81/E	44,00	54,12
6900-05-81/E	37,00	45,51
6900-06-81/E	30,00	36,90
6900-07-81/E	36,00	44,28



CZARNE, MATOWE ODBOJNIKI ZE STALI NIERDZEWNEJ

Katalog str. 100

NUMER KATALOGOWY	NETTO	BRUTTO
6900-01-57/E	101,00	124,23
6900-02-57/E	39,00	47,97
6900-03-57/E	44,00	54,12
6900-04-57/E	46,00	56,58
6900-05-57/E	39,00	47,97
6900-06-57/E	32,00	39,36
6900-07-57/E	38,00	46,74



SAMOZAMYKACZE

Katalog str. 101

PRODUKT	NETTO	BRUTTO
Samozamykacz z ramieniem AS 05	175,00	215,25
Samozamykacz z ramieniem AS 06	269,00	330,87
Samozamykacz z ramieniem AS 07	306,00	376,38



SZTYWNY ŁAŃCUCH

Katalog str. 108

KOD PRODUKTOWY	F6, F8: NETTO	F6, F8: BRUTTO
T73512181	221,00	271,83



ZAWIAS KRYTY





Katalog str. 108

NUMER KATALOGOWY PRODUKTU	NETTO	BRUTTO
19101849 80 kg srebrny	127,00	156,21
19101856 80 kg czarny	127,00	156,21
19101549 40 kg srebrny	119,00	146,37
19101556 40 kg czarny	119,00	146,37



AXA REMOTE 2.0

Katalog str. 109

PRODUKT	NUMER KATALOGOWY	NETTO	BRUTTO
 Kompletny system biały	29022098	697,00	857,31
 Kompletny system czarny	29022058	871,00	1071,33
 Kompletny system szary	29022096	697,00	857,31
 Kompletny system aluline	29020099	760,00	934,80
System zasilający 230V		176,00	216,48





fot. Diana Flex Premium, AXA©.

PRZEDSTAWICIELE REGIONALNI

Paweł Wersty

pawel.wersty@allegion.com
kom. 601 510 727

Dominik Mrówczyński

dominik.mrowczynski@allegion.com
kom. 601 356 593

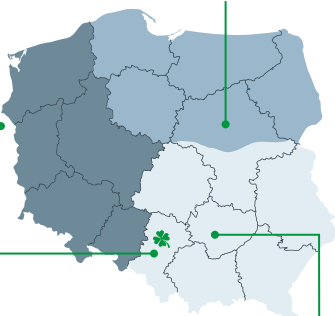

Dział handlowy

zamowienia@allegion.com
tel. +48 326 100 101
tel. +48 782 260 260
tel. +48 609 138 138
tel. +48 601 759 569

Adam Maliszewski

adam.maliszewski@allegion.com
kom. 605 298 391



AXA STENMAN POLAND SP. Z O.O.

ul. Technologiczna 8
42-400 Zawiercie
tel. +48 326 100 101
biuro@allegion.com
www.axahomesecurity.pl

ZNAJDŹ NAS NA:



Facebook:
@okuciadrzwi



YouTube:
AXA HomeSecurity PL



Instagram:
axa.homesecurity.pl



LinkedIn:
axa-stenman-poland



Strona WWW:
axahomesecurity.pl